

BÄRO

Retail  
Lighting

# XR LUMINAIRE SERIES

Ontero  
Intara  
Pendiri



Fresh, healthy, ecological, energy-efficient – our lifestyles and standards are changing. The range of products on offer is becoming more complex, guidance and trust more important. We are constantly searching for new types of lighting technology and are consistently developing new presentation options. For our customers. And our customers' customers.

Fresh Light *for* Fresh Products.

# Ontero Intara Pendiro

- P. 04 **Overview**  
XR luminaire series
- P. 08 **Ontero XR**  
Surface-mounted luminaire with power adapter
- P. 10 **Ontero XR**  
Surface mounted luminaire with in-track adapter
- P. 12 **Intara XR**  
Semi-recessed luminaire
- P. 14 **Intara XR**  
Recessed luminaire
- P. 16 **Pendiro XR**  
Suspended luminaire
- P. 18 **BÄRO individual**  
Customised design
- P. 20 **XR Colour Code**  
In the right light
- P. 26 **XR lighting technology**  
Power ratings and light spectrums
- P. 38 **Product overview**  
Variants and product numbers
- P. 46 **Service**  
Your lighting partner. Right from the start.  
Publishing details



# XR luminaire series

ONTERO, INTARA, PENDIRO

The XR luminaire series is a coherent system for customised lighting concepts in projects with all kinds of different formats, dimensions and requirements.

The professional lighting tools combine compact dimensions with high-quality design and innovative lighting technology.

Various beam angles in combination with application-neutral and colour-intensifying light colours offer numerous design variations.



## UNUSUAL AND ELEGANT

With the expansion of the BÄRO XR luminaire series almost all functions of an individual lighting solution can be realised.

Two different surface-mounted luminaires, a semi-recessed, a recessed and a suspended luminaire in the XR series offer high lighting quality coupled with a very compact design.





4 WATTAGES\*  
15 W . 23 W .  
34 W . 41 W  
\* Depending on the type of luminaire

7 LIGHT COLOURS  
927 . 830 . 835 . 840 .  
PearlWhite . BeColor .  
BeCool

5 BEAM ANGLES  
4 rotation-symmetrical  
(NarrowSpot 10°, Spot 20°,  
Medium 25°, Flood 44°),  
1 asymmetrical (OvalBasic  
60°x40°). OvalBasic can be  
pivoted by 90°.

EFFICIENCIES  
Luminaire luminous fluxes: up to 4,590lm  
Luminous efficacy: 146lm/W

CONTROL  
Constant Current .  
DALI (Ontero XR with power adapter,  
Intara XR semi-recessed, Pendiro XR) .  
Potentiometer (Ontero XR with power  
adapter, Intara XR semi-recessed) .  
Casambi on request

INDIVIDUAL  
Various colour combinations, RAL and NCS  
colours, galvanised surfaces.  
With metallic surfaces the usable power is  
reduced to max. 23 W.

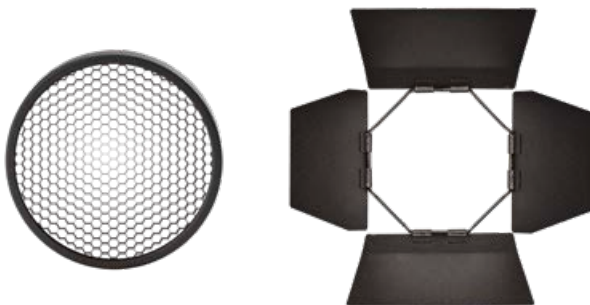

ACCESSORIES  
Honeycomb louver (for  
NarrowSpot, Spot and Medium  
reflector), anti-glare flaps.

# Ontero XR

WITH POWER ADAPTER

For the all-rounder of the XR series the driver electronics were newly developed to match the compact luminaire design. They are accommodated in the power adapter which has also been redesigned.

In addition to a standard constant current version, the track-mounted spotlight is also available as a version with potentiometer for manual brightness adjustment or as a DALI version for integration into a lighting management system.



## VARIABLE APPLICATIONS

As a flexible, controllable track-mounted spotlight, Ontero XR enables dynamic lighting concepts to be realised.

## LED HYBRID TECHNOLOGY

The proven combination of reflector and lens system produces light distribution patterns with clean and soft light cones.



# Ontero XR

Surface mounted luminaire with power adapter

COLOUR CODE	927	830	835	840
Luminaire luminous flux [lm]	3,260	4,210	4,250	4,360
System wattage [W]	41	41	41	41

COLOUR SPECTRUM	PearlWhite	BeColor
Luminaire luminous flux [lm]	3,440	2,980
System wattage [W]	41	41

COLOUR SPECTRUM	BeCool
Luminaire luminous flux [lm]	3,060
System wattage [W]	41

- Available wattages: 15 W, 23 W, 34 W (Constant Current/ DALI 100% - 1%), 41 W (DALI 100% - 1%, POTI 100% - 12%)
- The maximum system power and the resulting luminaire luminous fluxes for the reflector Medium 25° are stated.
- All data are typical values. System features may change with product improvements due to technical advances.



ONTERO XR WITH MEDIUM REFLECTOR

Surface-mounted luminaire with LED, rated lamp lifetime of the LEDs L80/10 > 50,000h, chromaticity point tolerance 2 SDCM (initial), LED hybrid technology, (reflector-lens combination for NarrowSpot, Spot, Medium), 3D silicone lens to reduce the proportion of scattered light, reflector 99.99% pure aluminium in MIRO-SILVER®, luminaire head pivoted, adjustable, glass cover, luminaire head and supporting arm made of die-cast aluminium, strato black, strato silver, strato white, powder-coated, plastic power adapter, black, white, not suitable for single connector, driver unit camera compatible, protection rating IP 20, protection class I, weight 0.8 kg

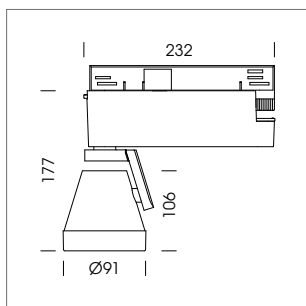

Further information and light distribution curves can be found from page 26 onwards

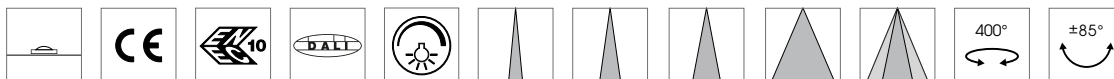

# Ontero XR

## THE COMPACT TOOL

The new in-track adapter with integrated driver electronics makes the additional version of the XR track-mounted spotlight appear even more compact.

This little power pack is designed for simpler, cost-efficient applications.



FLEXIBLE POSITIONING  
Vertical track installation  
(power reduced to 15 W)

# Ontero XR

Surface mounted luminaire with in-track adapter

COLOUR CODE	927	830	835	840
Luminaire luminous flux [lm]	2,970	3,840	3,870	3,970
System wattage [W]	34	34	34	34

COLOUR SPECTRUM	PearlWhite	BeColor
Luminaire luminous flux [lm]	3,160	2,680
System wattage [W]	34	34

COLOUR SPECTRUM	BeCool
Luminaire luminous flux [lm]	2,750
System wattage [W]	34



ONTERO XR WITH MEDIUM REFLECTOR

- Available wattages: 15 W, 34 W (Constant Current)
- The maximum system power and the resulting luminaire luminous fluxes for the reflector Medium 25° are stated.
- All data are typical values. System features may change with product improvements due to technical advances.

Surface-mounted luminaire with LED, rated lamp lifetime of the LEDs L80/10 > 50,000h, chromaticity point tolerance 2 SDCM (initial), reflector 99.99 % pure aluminium in MIRO-SILVER®, luminaire head pivoted, adjustable, glass cover, luminaire head and supporting arm made of die-cast aluminium, strato black, strato silver, strato white, powder-coated, in-track plastic power adapter, black, white, not suitable for single connector, driver unit camera compatible, protection rating IP 20, protection class II, weight 0.54 kg

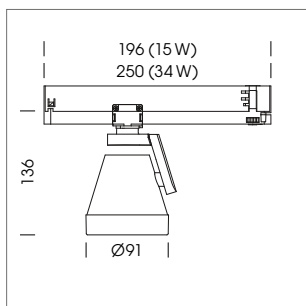

Further information and light distribution curves can be found from page 26 onwards

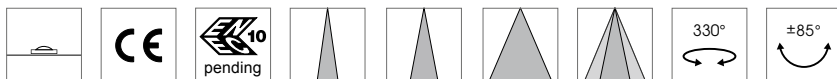

# Intara XR

## BRIGHT SPARK

The concave shape of the ceiling mounting piece made of die-cast aluminium contributes to the low-key look of the Intara XR semi-recessed luminaire.

The Intara XR can be easily mounted without tools. Thanks to the shallow fitting depth, there are hardly any limits to the possible applications.



### BRIGHTNESS ADJUSTMENT

A potentiometer on the ceiling fitting enables simple dimming of the luminaire.

### THROUGH-WIRING INCLUDED

Modular driver concept for individual requirements and faster installation.

# Intara XR

Semi-recessed luminaire

COLOUR CODE	927	830	835	840
Luminaire luminous flux [lm]	3,260	4,210	4,250	4,360
System wattage [W]	41	41	41	41
COLOUR SPECTRUM	PearlWhite	BeColor		
Luminaire luminous flux [lm]	3,440	2,980		
System wattage [W]	41	41		
COLOUR SPECTRUM	BeCool			
Luminaire luminous flux [lm]	3,060			
System wattage [W]	41			

- Available wattages: 15 W, 23 W, 34 W, 41 W (Constant Current/ DALI 100 % - 1 %), 41 W (POTI 100 % - 12 %)
- The maximum system power and the resulting luminaire luminous fluxes for the reflector Medium 25° are stated.
- All data are typical values. System features may change with product improvements due to technical advances.



INTARA XR WITH MEDIUM REFLECTOR

Semi-recessed luminaire with LED, rated lamp lifetime of LED L80/B10 > 50,000 h, chromaticity point tolerance 2 SDCM (initial), LED hybrid technology, (reflector/lens combination for NarrowSpot, Spot, Medium), 3D silicone lens to reduce the proportion of scattered light, reflector 99.99 % pure aluminium in MIRO-SILVER®, luminaire head pivoted, adjustable, glass cover, luminaire head and supporting arm made of die-cast aluminium, strato black, strato silver, strato white, powder-coated, separate driver unit, camera compatible, protection rating IP 20, protection class III, weight 0.65 kg

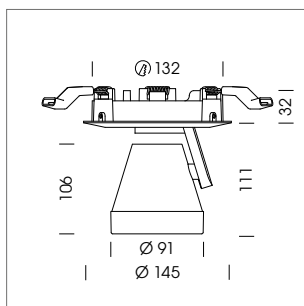

Further information and light distribution curves can be found from page 26 onwards

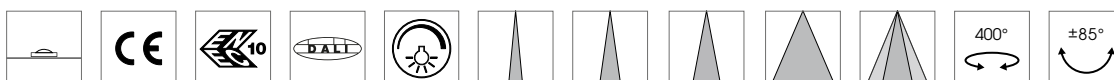

# Intara XR

HIGH QUALITY WITH A LOW-KEY LOOK

The recessed luminaire Intara XR completes the luminaire series. The round luminaire is ideal for an uncluttered and low-key ceiling look.

The 132 mm cut-out is identical to the ceiling cut-outs of the semi-recessed and suspended luminaires, ensuring a harmonious luminaire concept.

## FIRMLY CONNECTED

The fixed luminaire/driver combination enables quick and easy installation.

## QUICKLY WIRE

The electrical connection and the through-wiring are equally simple with a primary-side GST plug.

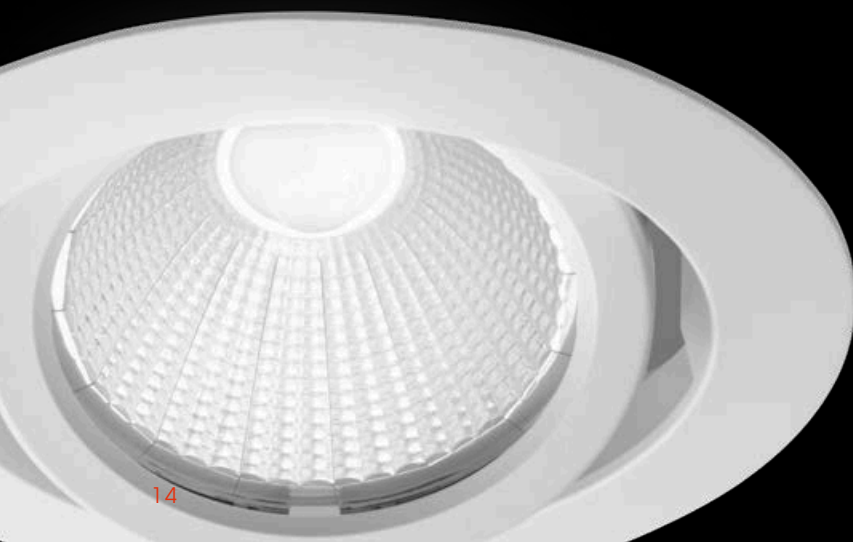



# Intara XR

Recessed luminaire

COLOUR CODE	927	830	835	840
Luminaire luminous flux [lm]	2,940	3,800	3,830	3,930
System wattage [W]	34	34	34	34

COLOUR SPECTRUM	PearlWhite	BeColor
Luminaire luminous flux [lm]	3,120	2,660
System wattage [W]	34	34

COLOUR SPECTRUM	BeCool
Luminaire luminous flux [lm]	2,730
System wattage [W]	34

- Available wattages: 15 W, 23 W, 34 W (Constant Current)
- The maximum system power and the resulting luminaire luminous fluxes for the reflector Medium 25° are stated.
- All data are typical values. System features may change with product improvements due to technical advances.



INTARA XR WITH MEDIUM REFLECTOR

Recessed luminaire with LED, rated lamp lifetime of the LEDs L80/10 > 50,000 h, chromaticity point tolerance 2 SDCM (initial), reflector 99.99 % pure aluminium in MIRO-SILVER®, luminaire head adjustable, glass cover, luminaire head and fitting ring made of die-cast aluminium, strato black, strato silver, strato white, firmly connected driver unit, incl. primary side feed cable with GST 18/3 plug, camera compatible, protection rating IP20, protection class I, weight 0.65 kg

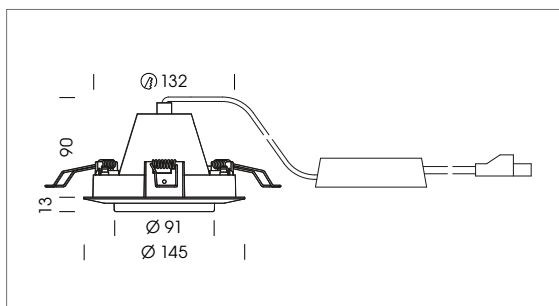

Further information and light distribution curves can be found from page 26 onwards



# Pendiro XR

## AN ATMOSPHERIC HIGHLIGHT

Compact, elegant and flexible: the Pendiro XR is suspended from a transparent coaxial cable that can be adjusted from 1,000 mm to 2,000 mm.

In addition to the surface-mounted version and the version with a track adapter, the suspended luminaire is also available with the Intara XR concave recessed ceiling fitting.



### DELICATE SUSPENSION CABLE

The transparent coaxial cable provides mechanical stability and excellent electromagnetic compatibility.

### 3 ATTACHMENT OPTIONS

Recessed canopy, surface-mounted canopy, track canopy.

# Pendiro XR

Suspended luminaire

<b>COLOUR CODE</b>	927	830	835	840
--------------------	-----	-----	-----	-----

Luminaire luminous flux [lm]	2,170	2,800	2,830	2,900
System wattage [W]	23	23	23	23

<b>COLOUR SPECTRUM</b>	PearlWhite	BeColor
------------------------	------------	---------

Luminaire luminous flux [lm]	2,320	1,920
System wattage [W]	23	23

<b>COLOUR SPECTRUM</b>	BeCool
------------------------	--------

Luminaire luminous flux [lm]	1,970
System wattage [W]	23

- Available wattages: 15 W, 23 W (Constant Current/DALI 100% - 1% for recessed, DALI 100% - 7% for surface-/ track-mounted)
- The maximum system power and the resulting luminaire luminous fluxes for the reflector Medium 25° are stated.
- All data are typical values. System features may change with product improvements due to technical advances.



PENDIRO XR WITH MEDIUM REFLECTOR

Suspended luminaire with LED, rated lamp lifetime of the LEDs L80/10 > 50,000 h, chromaticity point tolerance 2 SDCM (initial), LED hybrid technology, (reflector/lens combination for NarrowSpot, Spot, Medium), 3D silicone lens to reduce the proportion of scattered light, reflector 99.99% pure aluminium in MIRO-SILVER®, glass cover, luminaire head made of die-cast aluminium, strato black, strato white, powder-coated, attachment options: surface-mounted canopy, track-mounted canopy (integrated driver unit), recessed canopy (separate driver unit), power supply via coaxial suspension cable, driver unit camera compatible, protection rating IP 20, protection class I/III (depending on type of attachment), weight 1.1 kg - 0.65 kg (depending on type of attachment)

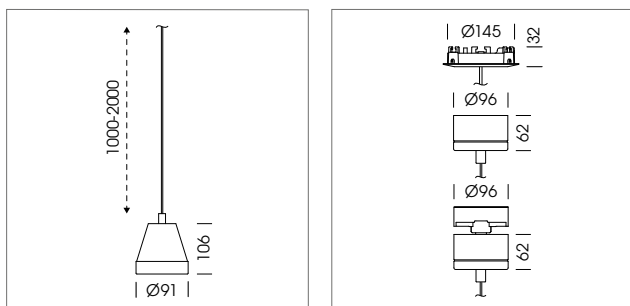

Further information and light distribution curves can be found from page 26 onwards

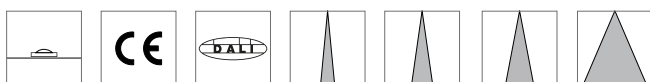

# Customised design

## BÄRO INDIVIDUAL

With BÄRO Individual any colour from the RAL or NCS range can be selected as a paint finish for our luminaires – an option that is of interest to both brand architects and designers of exclusive and unique interiors.

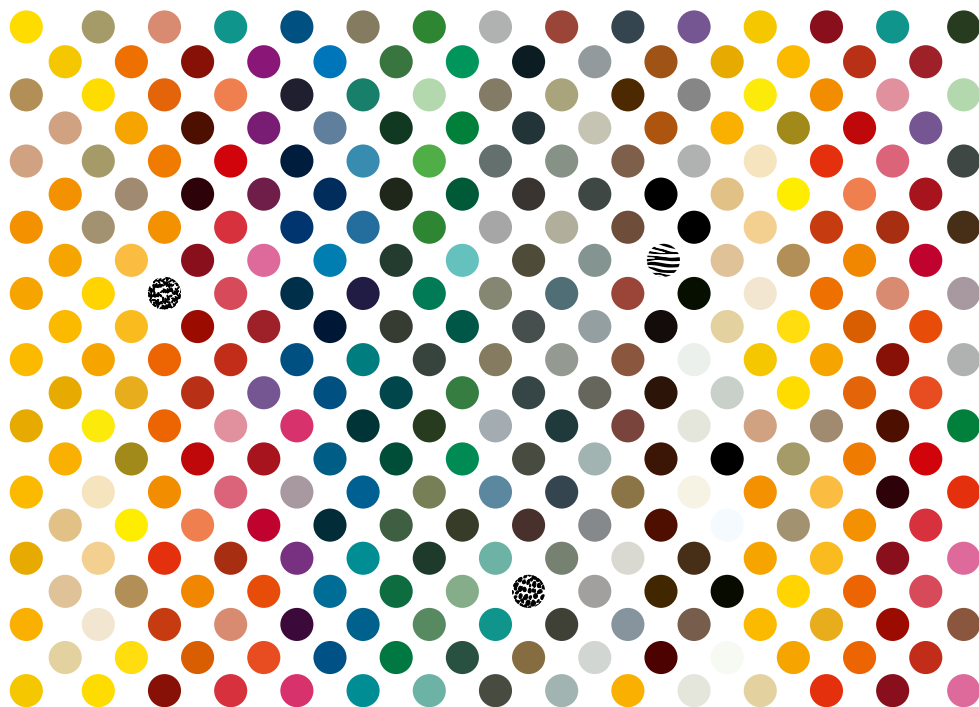



RAL  
painted



Nickel  
velour



Nickel  
matt

The design options are expanded even further with metallic surfaces such as glossy gold, glossy copper, burnished copper, nickel matt and nickel velour. BÄRO luminaires can be adapted to suit individual wishes, architectural styles or surrounding materials. Implementation of a corporate design can also be easily realised.

We believe that there is a difference between lighting and light. And that light has the power to touch people, to inspire them and to activate them. With this conviction – and decades of experience – we develop unique BÄRO special light colours.

This means that there is not one light for everything. But precisely the right light for every individual requirement – so that every product is shown in the best light.

BÄRO. The Colour *of* Light.





Euroshop 2017  
Presentation of the special light colour PearlWhite

# In the right light

## THE COLOUR-INTENSIFYING SPECTRUMS OF THE XR SERIES

Light that optimises the natural colours of products is one of the most effective, but also one of the most sophisticated tools of retail lighting. Thanks to decades of experience, BÄRO has the corresponding products, technologies and the necessary expertise.

Light creates an atmosphere – and it supports the sales-promoting presentation of all kinds of products. From fresh foodstuffs to non-food products, fashion and leisure articles – lighting with a coordinated spectral composition can render the colour, material and surface properties of products in a way that shows them off to best advantage to customers. Successful retail lighting must always strike a balance between technical effectiveness, economic efficiency and customer-oriented emotionality.

For example, in a boutique you see shoes in the new colours of the season. Their colour impression depends on several factors at this moment: an arti-

ficial light source illuminates the shoes with white light with a certain spectral composition, which rarely corresponds to the continuous spectrum of sunlight. On the other hand the surface of the shoes absorbs part of this light spectrum while reflecting other components of the light. These catch the eye where sensory cells measure the blue, green and red components of the light and convey them to the visual centre of the brain. Ultimately, a subjective colour impression is created.

As not the whole spectrum, but only three selective colour bands are measured and processed by the brain, the metamerism phenomenon occurs: light with a different composition can

produce the same colour impression for the viewer – and body colours that looked the same under certain lighting may differ greatly under different light.

For product illumination this means: if artificial light spectrums can be technically influenced, the perception of certain colour shades typical to products can be changed in a surprisingly wide range. Depending on the lighting the colour of the shoes can appear warmer or cooler, more or less saturated. The art of product lighting that optimises the products' own colours is to find light spectrums tailored to every application. BÄRO has been a trailblazer in this art for many years.

## OVERVIEW OF THE AVAILABLE LIGHT COLOURS

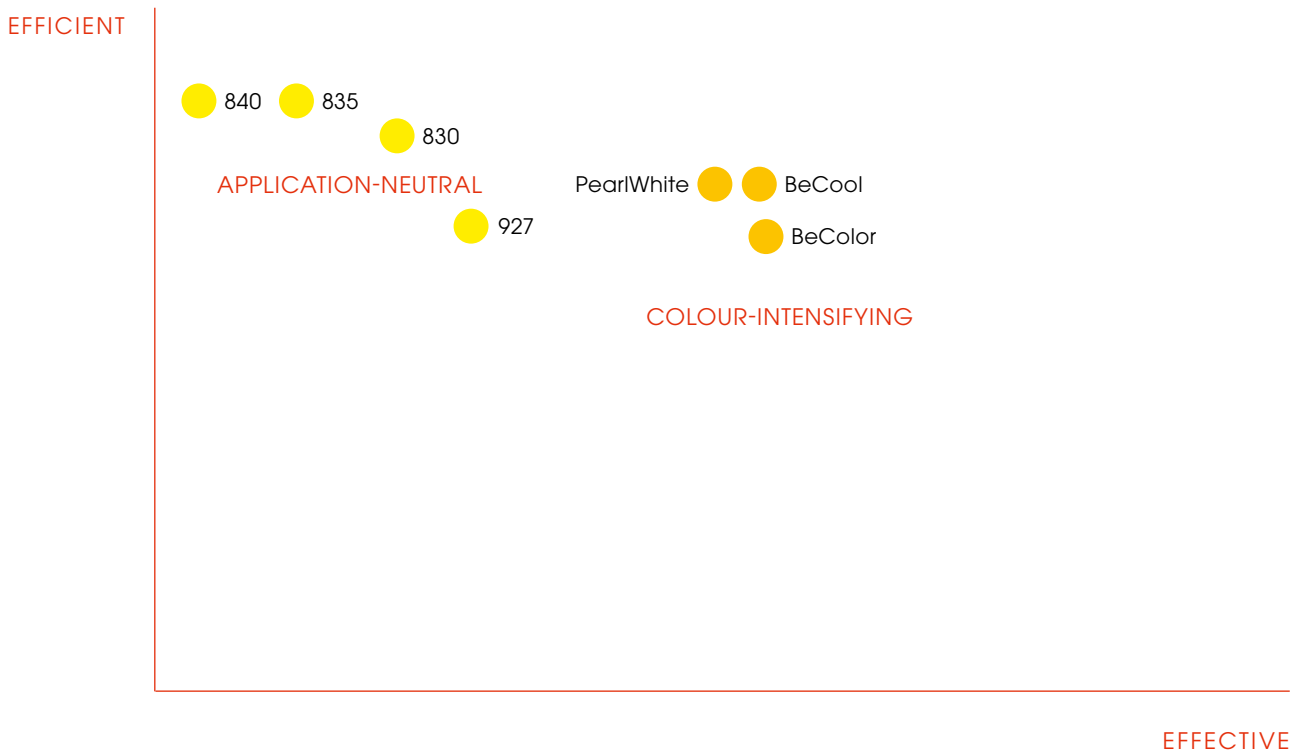

- Standard light colours with neutral colour rendering
- Special light colours with higher colour saturation

The selection of the right light colour is always a balance between maximum efficiency and optimum product presentation.

Do not hesitate to contact BÄRO and take advantage of the company's expertise and experience if you would like to use light optimising natural colours in your projects as a retailer, retail designer or lighting planner. Our experts will be pleased to advise you – from the design and detailed planning up to the installation and alignment of the luminaires.

# "LED technology offers numerous starting points for defining light spectrums."

Here the experience with special light colours that BÄRO has acquired over many years and successfully transferred to LED technology is decisive. LEDs offers numerous starting points for defining and influencing light spectrums. BÄRO has developed a wide range of LED light colours in close cooperation with its technology partners. It is divided into standard light colours, colour-intensifying light colours and product-specific light colours to meet different requirements. Even the range of standard light colours that is oriented to the black body line is wider than usual: with the four white tones 927, 830, 835 and 840 it comprises

colour temperatures from a warm 2,700K to a neutral-cool 4,000 K.

As special light colours the colour-intensifying LED spectrums from BÄRO are also available for the XR series. Their chromaticity points are below the black body line; they make white shine cleanly and colours appear vibrant. PearlWhite saturates yellow and orange surfaces particularly well. BeColor particularly intensifies warm

body colours and makes surfaces appear naturally rich and colourful. And last but not least BeCool intensifies cooler body colours.

This means that no less than 7 LED light colours are available for the XR series, making it a professional instrument that enables a customised and harmonious light balance to be developed for many retail projects, brands and salesroom situations.

## The light spectrum

Visible light is the small portion of electromagnetic radiation that the human eye is able to see without technical aids.

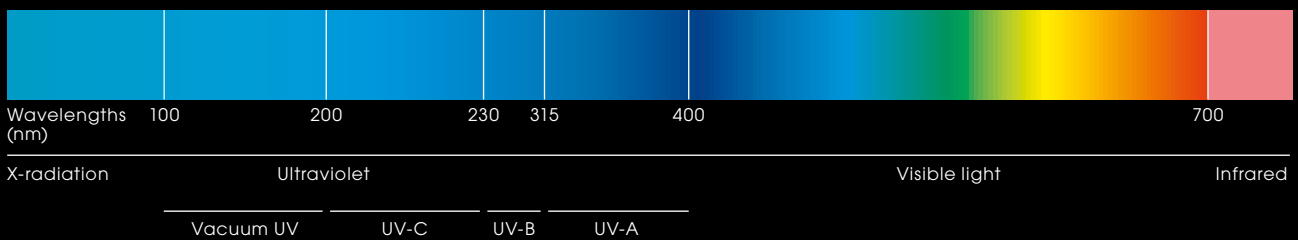

OVERVIEW OF LUMINAIRE LUMINOUS FLUXES

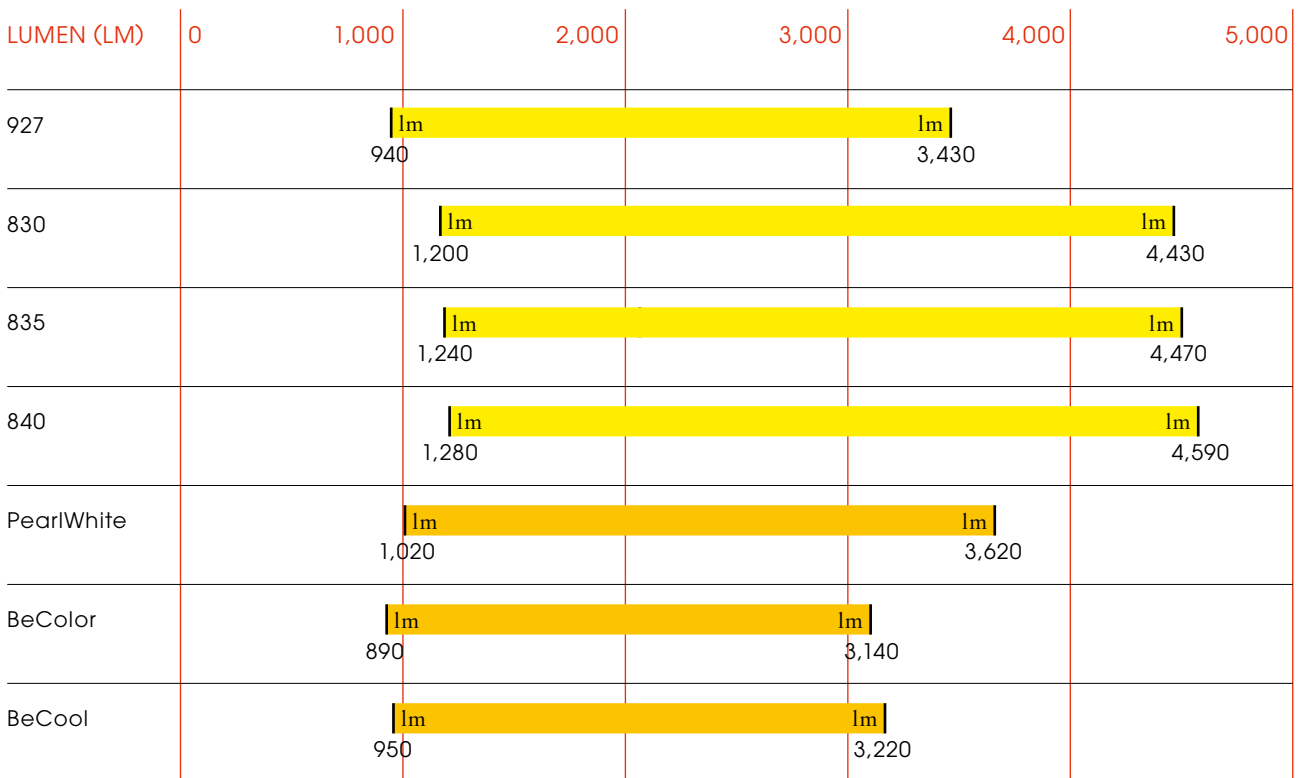

PearlWhite, BeColor and BeCool are light colours with a special spectral composition. They are the right choice for emphasising the quality of a product with particularly brilliant colour.

For the eye and the human brain, the colours of the illuminated objects or surfaces appear saturated. The very good colour rendering index CRI > 95 contributes to the intensive colour brilliance and colour radiance of the products.

# XR lighting technology

UNPARALLELED QUALITY



Highly efficient LED hybrid optics from BÄRO combine the advantages of reflectors and lens systems and produce a particularly balanced contrast between the focal point and the corona of the light cone.



LED hybrid technology with a special 3D silicone lens on the LED module ensures that less light is directly emitted and more light reaches the target surface in a controlled manner via the reflector facets. The innovative silicone lens material combines excellent optical properties with high durability and precision.

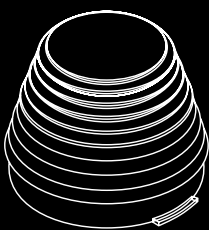

ADVANTAGES OF THE BÄRO SILICONE LENS:

- Form retaining and temperature resistant > 150°
- Resistant to ageing in visible and UV light
- Very high transmittance over the whole visible spectrum
- Extremely high optical quality thanks to precisely moulded structures
- Flexible and therefore particularly mechanically robust

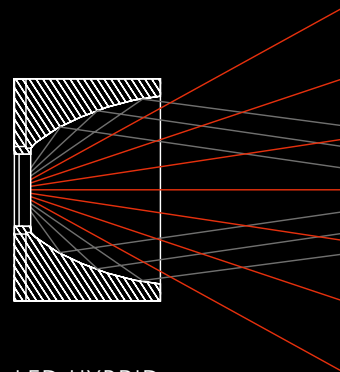
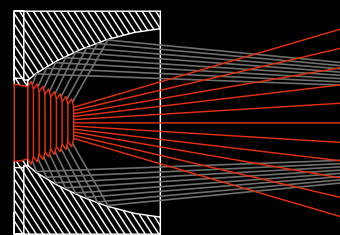

LED HYBRID TECHNOLOGY  
Comparison of light cone with (top) and without (bottom) silicone lens

# Beam characteristics

Example of the how the beam angle and the illuminance change.

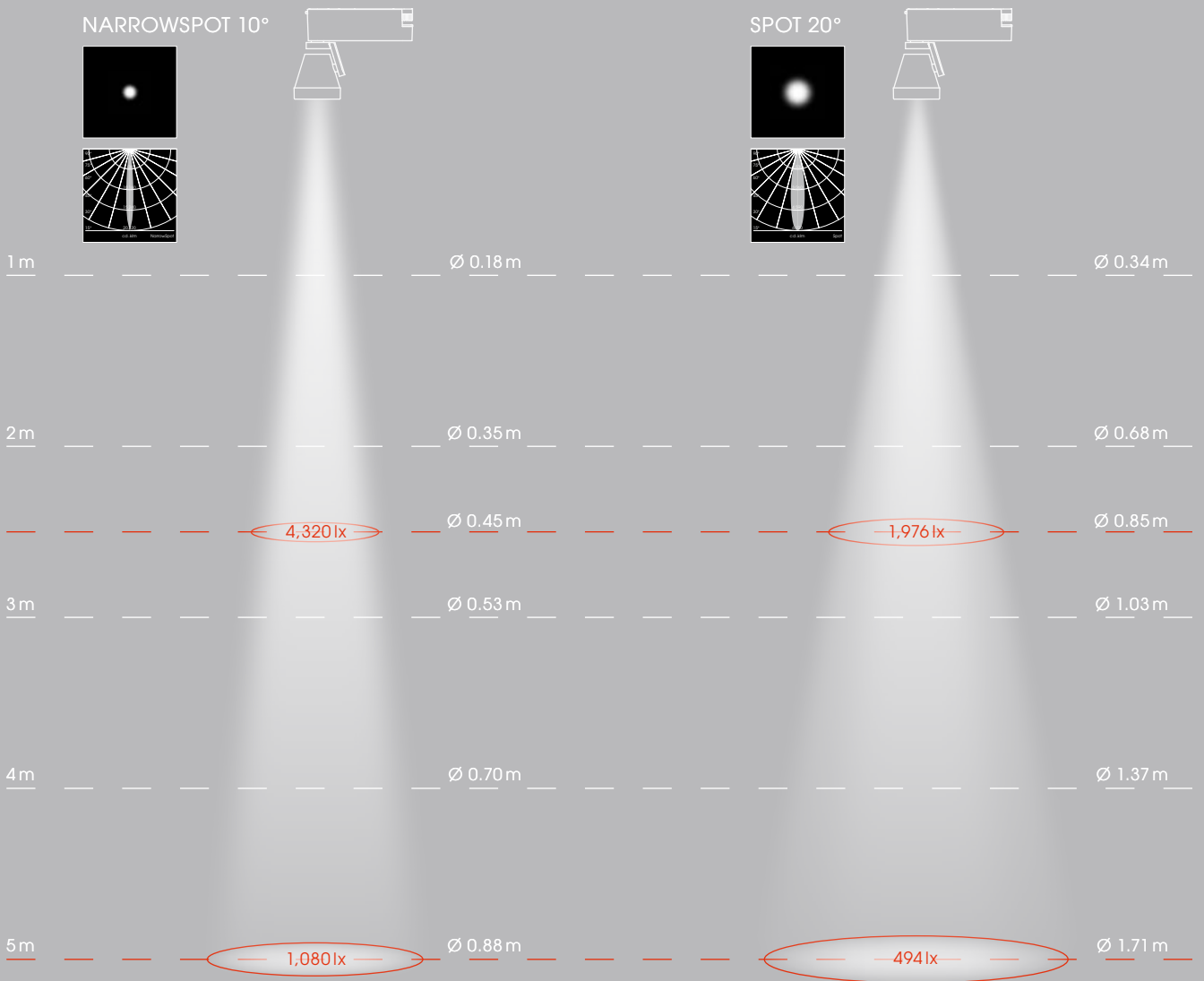

The beam angle defines the diameter of the light cone. A narrow, symmetrical beam angle (10°) bundles the light so strongly that surfaces are brightly illuminated, even from greater distances.

With a rotation-symmetrical reflector the diameter of the light cone increases proportionally with the distance, while the illuminance decreases with the square of the distance.

MEDIUM 25°

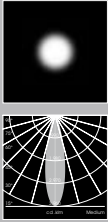

Ø 0.44 m

Ø 0.87 m

1,272 lx

Ø 1.10 m

Ø 1.31 m

318 lx

Ø 2.18 m

FLOOD 44°

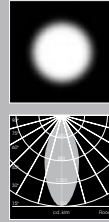

Ø 0.81 m

Ø 1.62 m

585 lx

Ø 2.02 m

Ø 2.44 m

146 lx

Ø 4.06 m

With a rotation-symmetrical reflector the diameter of the light cone increases proportionally with the distance, while the illuminance decreases with the square of the distance.

The values given in the examples apply to Ontero XR with power adapter, 830, 15 W.

# Special light distribution

Examples of horizontal and vertical light channelling

## OVALBASIC REFLECTOR

OvalBasic reflectors are ideal for homogeneous illumination of long product displays from a normal room height with simultaneous illumination of vertical surfaces. With regular arrangement and rotated by 90°, in addition to illuminating narrow elements they can also be used for the even illumination of wall surfaces.

40° × 60°

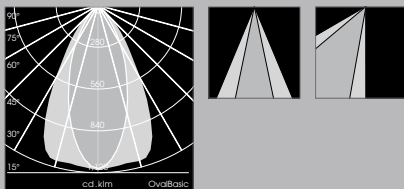

60° × 40°

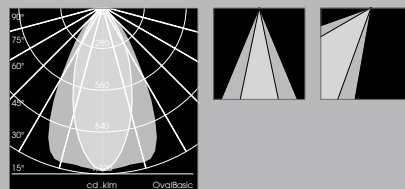

Number of luminaires	5
Distance to illuminated surface [m]	1.00
Distance between luminaires [m]	1.25
Mounting height [m]	3.00

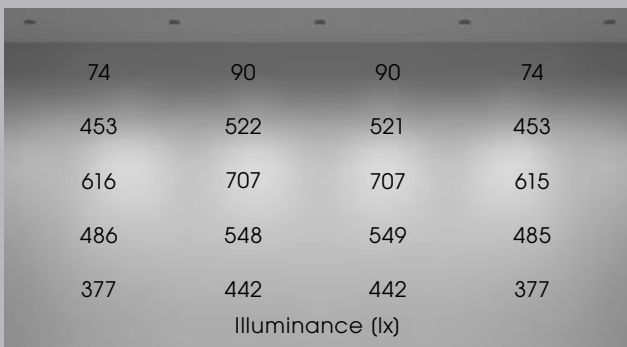

835 . 34W . 3,870lm . 114lm/W

The example shows the light distribution and illuminances on the wall when the reflector is aligned horizontally and the luminaire is pivoted by 15°.

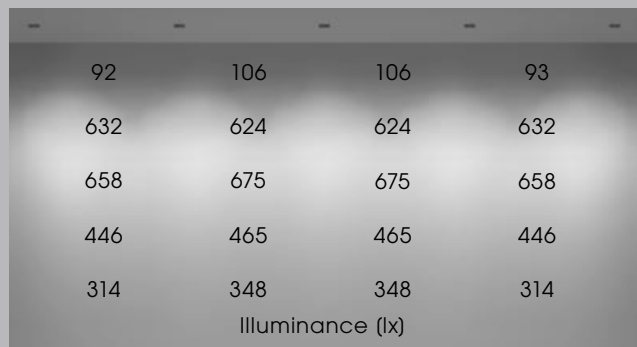

835 . 34W . 3,870lm . 114lm/W

The example shows the light distribution and illuminances on the wall when the reflector is aligned vertically and the luminaire is pivoted by 15°.

The luminaire luminous flux figures vary in a tolerance range of ±10%. Please refer to our data sheets at [www.baero.com](http://www.baero.com) for further technical details on the individual products. All data are typical values. System features may change with product improvements due to technical advances. Errors excepted.

# 927

## Colour Code

The warm white LED spectrum of the standard light colour is ideal for illuminating goods and product types with warm colours and for creating a harmonious atmosphere. The very good colour rendering gives the surfaces a high-quality appearance and even the smallest colour nuances are clearly apparent.

### REFLECTORS

### WATTAGES

15W      23W      34W      41W

### NARROWSPOT

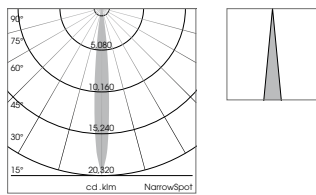

Luminaire luminous flux [lm]  
Luminous efficacy [lm/W]

1,040      –      –      –  
69      –      –      –

Illuminance [lx]

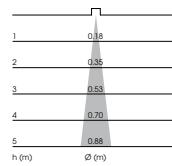

1	0.18	21,120	–	–	–
2	0.35	5,280	–	–	–
3	0.53	2,347	–	–	–
4	0.70	1,320	–	–	–
5	0.88	845	–	–	–

### SPOT

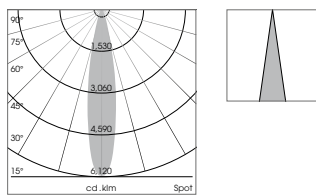

Luminaire luminous flux [lm]  
Luminous efficacy [lm/W]

1,570      2,190      2,860      3,300  
105      95      84      80

Illuminance [lx]

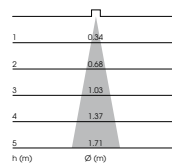

1	0.34	9,553	13,325	17,402	20,079
2	0.68	2,388	3,331	4,350	5,020
3	1.03	1,061	1,481	1,934	2,231
4	1.37	597	833	1,088	1,255
5	1.71	382	533	696	803

### MEDIUM

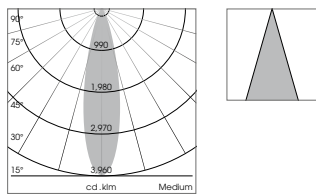

Luminaire luminous flux [lm]  
Luminous efficacy [lm/W]

1,560      2,170      2,830      3,260  
104      94      83      80

Illuminance [lx]

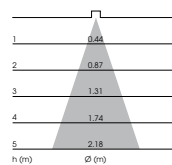

1	0.44	6,172	8,585	11,196	12,897
2	0.87	1,543	2,146	2,799	3,224
3	1.31	686	954	1,244	1,433
4	1.74	386	537	700	806
5	2.18	247	343	448	516

### FLOOD

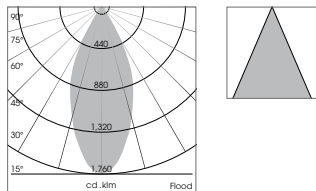

Luminaire luminous flux [lm]  
Luminous efficacy [lm/W]

1,610      2,250      2,930      3,380  
107      98      86      82

Illuminance [lx]

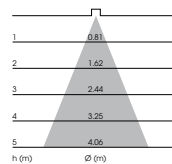

1	0.81	2,833	3,959	5,156	5,947
2	1.62	708	990	1,289	1,487
3	2.44	315	440	573	661
4	3.25	177	247	322	372
5	4.06	113	158	206	238

### OVALBASIC

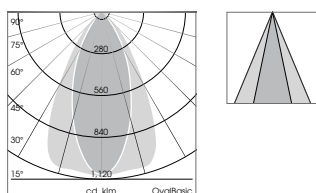

Luminaire luminous flux [lm]  
Luminous efficacy [lm/W]

1,640      2,290      2,970      3,430  
109      100      87      84

Illuminance [lx]

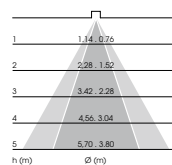

1	1.14	1,803	2,518	3,266	3,771
2	2.28	451	629	816	943
3	3.42	200	280	363	419
4	4.56	113	157	204	236
5	5.70	72	101	131	151

The luminaire luminous flux figures vary in a tolerance range of ±10%. Please refer to our data sheets at [www.baero.com](http://www.baero.com) for further technical details on the individual products. All data are typical values. System features may change with product improvements due to technical advances. Errors excepted.

# 830

## Colour Code

The warm white LED spectrum of the standard light colour is primarily used for efficient lighting when consistent good colour rendering of the colours is desired for all objects being illuminated.

### REFLECTORS

### WATTAGES

15W      23W      34W      41W

#### NARROWSPOT

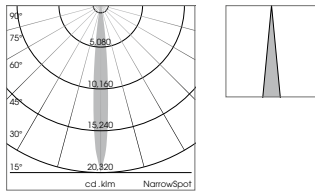

Luminaire luminous flux [lm]  
Luminous efficacy [lm/W]

1,330      -      -      -  
89      -      -      -

Illuminance [lx]

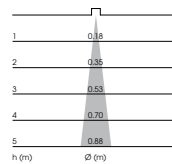

27,009      -      -      -  
6,752      -      -      -  
3,001      -      -      -  
1,688      -      -      -  
1,080      -      -      -

#### SPOT

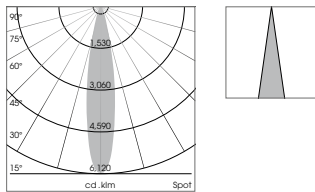

Luminaire luminous flux [lm]  
Luminous efficacy [lm/W]

2,030      2,830      3,690      4,260  
135      123      109      104

Illuminance [lx]

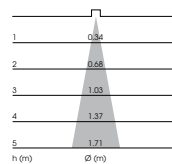

12,352      17,219      22,452      25,920  
3,088      4,305      5,613      6,480  
1,372      1,913      2,495      2,880  
772      1,076      1,403      1,620  
494      689      898      1,037

#### MEDIUM

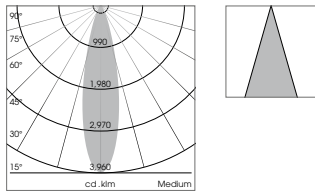

Luminaire luminous flux [lm]  
Luminous efficacy [lm/W]

2,010      2,800      3,650      4,210  
134      122      107      103

Illuminance [lx]

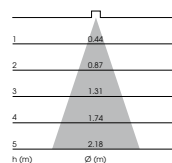

7,952      11,077      14,440      16,656  
1,988      2,769      3,610      4,164  
884      1,231      1,604      1,851  
497      692      903      1,041  
318      443      578      666

#### FLOOD

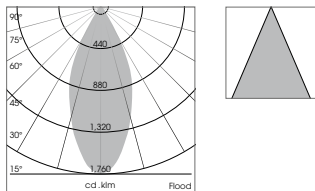

Luminaire luminous flux [lm]  
Luminous efficacy [lm/W]

2,080      2,900      3,780      4,360  
139      126      111      106

Illuminance [lx]

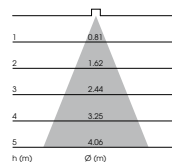

3,660      5,103      6,651      7,672  
915      1,276      1,663      1,918  
407      567      739      852  
229      319      416      479  
146      204      266      307

#### OVALBASIC

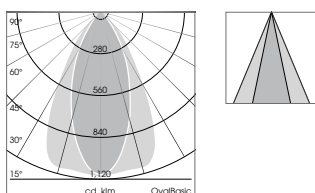

Luminaire luminous flux [lm]  
Luminous efficacy [lm/W]

2,110      2,950      3,840      4,430  
141      128      113      108

Illuminance [lx]

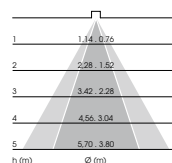

2,320      3,244      4,222      4,871  
580      811      1,056      1,218  
258      360      469      541  
145      203      264      304  
93      130      169      195

The luminaire luminous flux figures vary in a tolerance range of  $\pm 10\%$ . Please refer to our data sheets at [www.baero.com](http://www.baero.com) for further technical details on the individual products. All data are typical values. System features may change with product improvements due to technical advances. Errors excepted.

# 835

## Colour Code

The LED spectrum of the standard light colour is between neutral white and warm white and is suitable for use wherever the aim is to efficiently showcase products with an emphasis on their fresh colours or to create a corresponding spatial atmosphere.

### REFLECTORS

### WATTAGES

15W      23W      34W      41W

#### NARROWSPOT

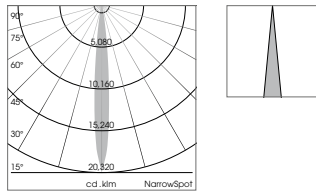

Luminaire luminous flux [lm]  
Luminous efficacy [lm/W]

1,380      -      -      -  
92      -      -      -

Illuminance [lx]

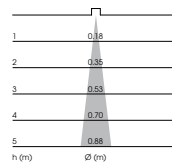

28,025      -      -      -  
7,006      -      -      -  
3,114      -      -      -  
1,752      -      -      -  
1,121      -      -      -

#### SPOT

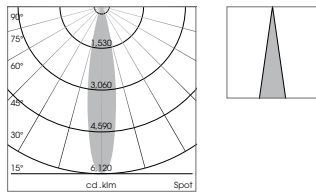

Luminaire luminous flux [lm]  
Luminous efficacy [lm/W]

2,050      2,860      3,720      4,290  
137      124      109      105

Illuminance [lx]

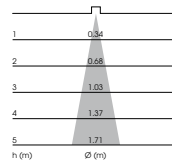

12,473      17,402      22,635      26,103  
3,118      4,350      5,659      6,526  
1,386      1,934      2,515      2,900  
780      1,088      1,415      1,631  
499      696      905      1,044

#### MEDIUM

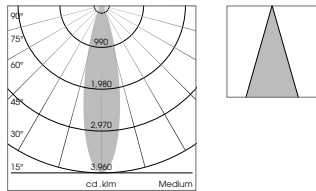

Luminaire luminous flux [lm]  
Luminous efficacy [lm/W]

2,030      2,830      3,680      4,250  
135      123      108      104

Illuminance [lx]

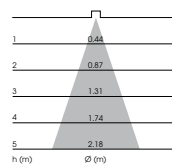

8,031      11,196      14,559      16,814  
2,008      2,799      3,640      4,203  
892      1,244      1,618      1,868  
502      700      910      1,051  
321      448      582      673

#### FLOOD

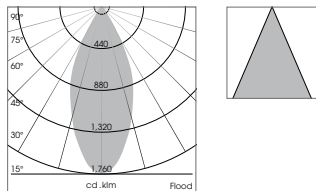

Luminaire luminous flux [lm]  
Luminous efficacy [lm/W]

2,110      2,930      3,810      4,400  
141      127      112      107

Illuminance [lx]

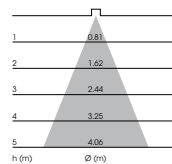

3,713      5,156      6,704      7,742  
928      1,289      1,676      1,936  
413      573      745      860  
232      322      419      484  
149      206      268      310

#### OVALBASIC

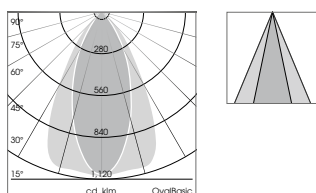

Luminaire luminous flux [lm]  
Luminous efficacy [lm/W]

2,140      2,980      3,870      4,470  
143      130      114      109

Illuminance [lx]

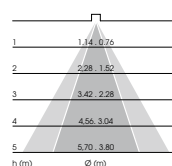

2,353      3,277      4,255      4,915  
588      819      1,064      1,229  
261      364      473      546  
147      205      266      307  
94      131      170      197

The luminaire luminous flux figures vary in a tolerance range of ±10%. Please refer to our data sheets at [www.baero.com](http://www.baero.com) for further technical details on the individual products. All data are typical values. System features may change with product improvements due to technical advances. Errors excepted.

# 840

## Colour Code

As a standard light colour, the neutral white LED spectrum is suitable for the efficient illumination of clear body colours or to create a cooler spatial impression.

### REFLECTORS

### WATTAGES

15 W

23 W

34 W

41 W

### NARROWSPOT

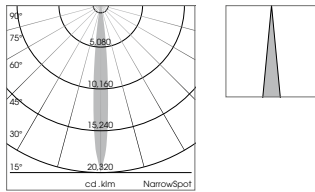

Luminaire luminous flux [lm]  
Luminous efficacy [lm/W]

1,420

–

–

–

99

–

–

–

Illuminance [lx]

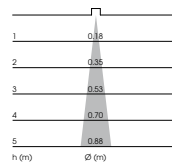

28,837

–

–

–

7,209

–

–

–

3,204

–

–

–

1,802

–

–

–

1,153

–

–

–

### SPOT

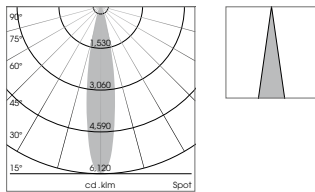

Luminaire luminous flux [lm]  
Luminous efficacy [lm/W]

2,100

2,930

3,820

4,400

140

127

112

107

Illuminance [lx]

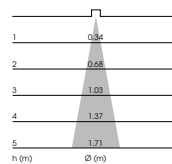

12,778

17,828

23,243

26,772

3,194

4,457

5,811

6,693

1,420

1,981

2,583

2,975

799

1,114

1,453

1,673

511

713

930

1,071

### MEDIUM

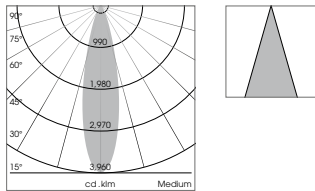

Luminaire luminous flux [lm]  
Luminous efficacy [lm/W]

2,080

2,900

3,780

4,360

139

126

111

106

Illuminance [lx]

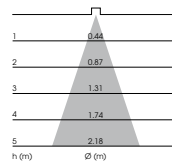

8,229

11,473

14,954

17,249

2,057

2,868

3,739

4,312

914

1,275

1,662

1,917

514

717

935

1,078

329

459

598

690

### FLOOD

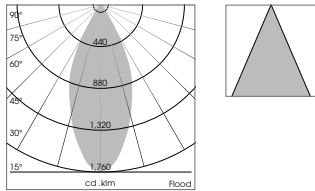

Luminaire luminous flux [lm]  
Luminous efficacy [lm/W]

2,150

3,010

3,910

4,510

143

131

115

110

Illuminance [lx]

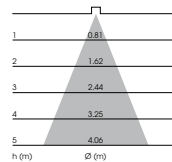

3,783

5,296

6,880

7,936

946

1,324

1,720

1,984

420

588

764

882

236

331

430

496

151

212

275

317

### OVALBASIC

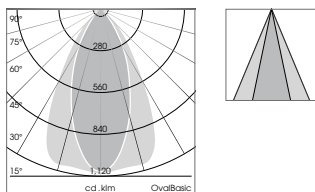

Luminaire luminous flux [lm]  
Luminous efficacy [lm/W]

2,190

3,050

3,970

4,590

146

133

117

112

Illuminance [lx]

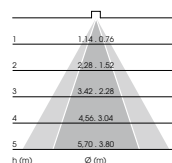

2,408

3,353

4,365

5,047

602

838

1,091

1,262

268

373

485

561

150

210

273

315

96

134

175

202

The luminaire luminous flux figures vary in a tolerance range of  $\pm 10\%$ . Please refer to our data sheets at [www.baero.com](http://www.baero.com) for further technical details on the individual products. All data are typical values. System features may change with product improvements due to technical advances. Errors excepted.



# PearlWhite

## Colour Spectrum

The LED spectrum of the special light colour is below the Planck curve (below black body). It has a colour-intensifying effect and creates an elegant atmosphere in the room. The correlated colour temperature is 3,100 K.

### REFLECTORS

### WATTAGES

15W      23W      34W      41W

#### NARROWSPOT

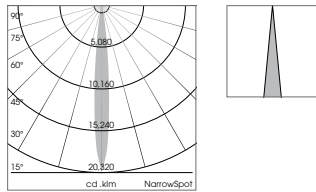

Luminaire luminous flux [lm]  
Luminous efficacy [lm/W]

1,120      -      -      -  
75      -      -      -

Illuminance [lx]

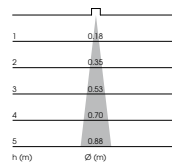

22,745      -      -      -  
5,686      -      -      -  
2,527      -      -      -  
1,422      -      -      -  
910      -      -      -

#### SPOT

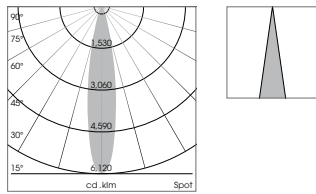

Luminaire luminous flux [lm]  
Luminous efficacy [lm/W]

1,680      2,340      3,030      3,480  
112      102      89      85

Illuminance [lx]

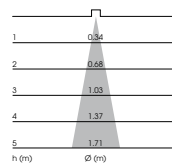

10,222      14,238      18,436      21,174  
2,556      3,559      4,609      5,294  
1,136      1,582      2,048      2,353  
639      890      1,152      1,323  
409      570      737      847

#### MEDIUM

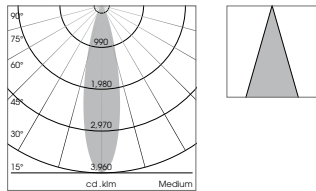

Luminaire luminous flux [lm]  
Luminous efficacy [lm/W]

1,660      2,320      3,000      3,440  
111      101      88      84

Illuminance [lx]

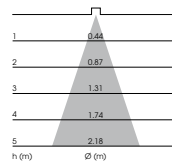

6,567      9,178      11,869      13,609  
1,642      2,295      2,967      3,402  
730      1,020      1,319      1,512  
410      574      742      851  
263      367      475      544

#### FLOOD

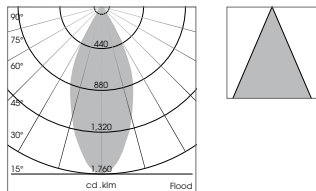

Luminaire luminous flux [lm]  
Luminous efficacy [lm/W]

1,720      2,400      3,110      3,570  
115      104      91      87

Illuminance [lx]

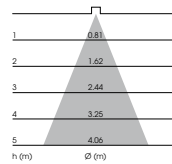

3,027      4,223      5,472      6,282  
757      1,056      1,368      1,570  
336      469      608      698  
189      264      342      393  
121      169      219      251

#### OVALBASIC

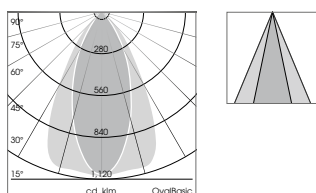

Luminaire luminous flux [lm]  
Luminous efficacy [lm/W]

1,750      2,440      3,160      3,620  
117      106      93      88

Illuminance [lx]

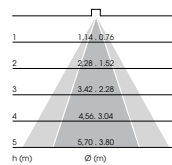

1,924      2,683      3,474      3,980  
481      671      869      995  
214      298      386      442  
120      168      217      249  
77      107      139      159

The luminaire luminous flux figures vary in a tolerance range of ±10%. Please refer to our data sheets at [www.baero.com](http://www.baero.com) for further technical details on the individual products. All data are typical values. System features may change with product improvements due to technical advances. Errors excepted.

# BeColor

## Colour Spectrum

The colour-intensifying LED spectrum of the special light colour is below the Planck curve (below black body). The surfaces appear both rich and brilliant. The correlated colour temperature is 3,500 K.

### REFLECTORS

### WATTAGES

15 W

23 W

34 W

41 W

### NARROWSPOT

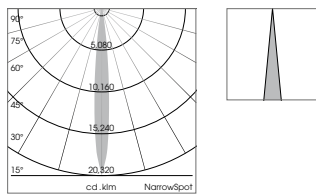

Luminaire luminous flux [lm]  
Luminous efficacy [lm/W]

990      –      –      –  
66      –      –      –

Illuminance [lx]

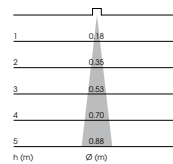

20,105      –      –      –  
5,026      –      –      –  
2,234      –      –      –  
1,257      –      –      –  
804      –      –      –

### SPOT

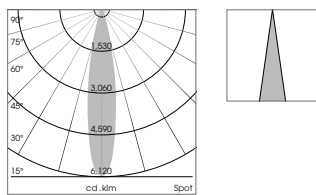

Luminaire luminous flux [lm]  
Luminous efficacy [lm/W]

1,370      1,940      2,570      3,010  
91      84      76      73

Illuminance [lx]

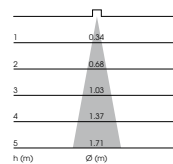

8,336      11,804      15,637      18,315  
2,084      2,951      3,909      4,579  
926      1,312      1,737      2,035  
521      738      977      1,145  
333      472      625      733

### MEDIUM

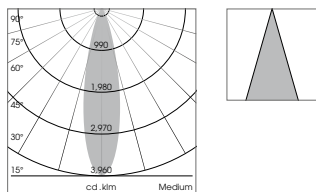

Luminaire luminous flux [lm]  
Luminous efficacy [lm/W]

1,350      1,920      2,550      2,980  
90      83      75      73

Illuminance [lx]

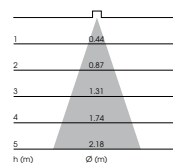

5,341      7,596      10,088      11,789  
1,335      1,899      2,522      2,947  
593      844      1,121      1,310  
334      475      631      737  
214      304      404      472

### FLOOD

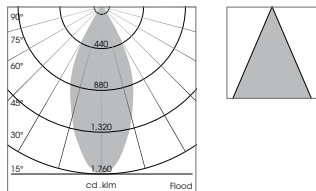

Luminaire luminous flux [lm]  
Luminous efficacy [lm/W]

1,400      1,990      2,640      3,090  
93      87      78      75

Illuminance [lx]

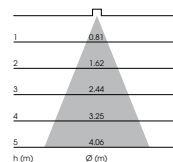

2,463      3,502      4,645      5,437  
616      875      1,161      1,359  
274      389      516      604  
154      219      290      340  
99      140      186      217

### OVALBASIC

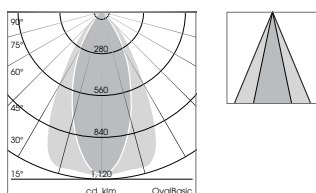

Luminaire luminous flux [lm]  
Luminous efficacy [lm/W]

1,430      2,020      2,680      3,140  
95      88      79      77

Illuminance [lx]

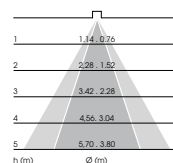

1,572      2,221      2,947      3,452  
393      555      737      863  
175      247      327      384  
98      139      184      216  
63      89      118      138

The luminaire luminous flux figures vary in a tolerance range of ±10%. Please refer to our data sheets at [www.baero.com](http://www.baero.com) for further technical details on the individual products. All data are typical values. System features may change with product improvements due to technical advances. Errors excepted.

# BeCool

## Colour Spectrum

BeCool is a special light colour with an LED spectrum below the Planck curve (below black body). The colour-intensified impression of the illuminated surfaces or body colours appears cool and saturated. The correlated colour temperature is 4,000 K.

### REFLECTORS

### WATTAGES

15W      23W      34W      41W

#### NARROWSPOT

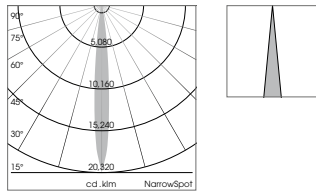

Luminaire luminous flux [lm]  
Luminous efficacy [lm/W]

1,060      -      -      -  
71      -      -      -

Illuminance [lx]

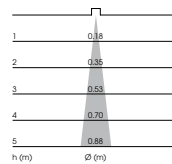

21,526      -      -      -  
5,382      -      -      -  
2,392      -      -      -  
1,345      -      -      -  
861      -      -      -

#### SPOT

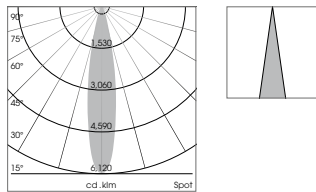

Luminaire luminous flux [lm]  
Luminous efficacy [lm/W]

1,400      1,990      2,640      3,090  
93      87      78      75

Illuminance [lx]

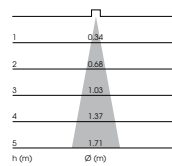

8,518      12,108      16,063      18,801  
2,130      3,027      4,016      4,700  
946      1,345      1,785      2,089  
532      757      1,004      1,175  
341      484      643      752

#### MEDIUM

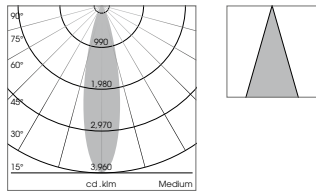

Luminaire luminous flux [lm]  
Luminous efficacy [lm/W]

1,390      1,970      2,610      3,060  
93      86      77      75

Illuminance [lx]

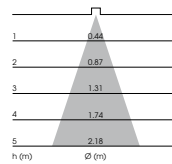

5,499      7,794      10,326      12,106  
1,375      1,948      2,581      3,026  
611      866      1,147      1,345  
344      487      645      757  
220      312      413      484

#### FLOOD

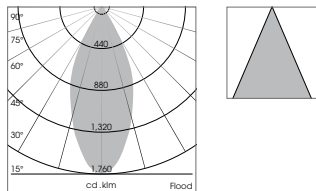

Luminaire luminous flux [lm]  
Luminous efficacy [lm/W]

1,440      2,040      2,710      3,170  
96      89      80      77

Illuminance [lx]

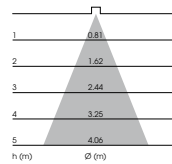

2,534      3,590      4,769      5,578  
633      897      1,192      1,394  
282      399      530      620  
158      224      298      349  
101      144      191      223

#### OVALBASIC

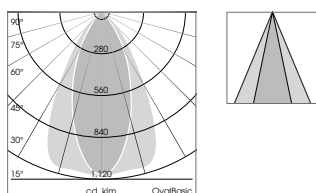

Luminaire luminous flux [lm]  
Luminous efficacy [lm/W]

1,460      2,080      2,750      3,220  
97      90      81      79

Illuminance [lx]

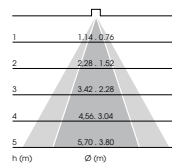

1,605      2,287      3,024      3,540  
401      572      756      885  
178      254      336      393  
100      143      189      221  
64      91      121      142

The luminaire luminous flux figures vary in a tolerance range of ±10%. Please refer to our data sheets at [www.baero.com](http://www.baero.com) for further technical details on the individual products. All data are typical values. System features may change with product improvements due to technical advances. Errors excepted.

# Ontero XR

Surface-mounted luminaire  
with power adapter

In the 15W, 23W and 34W power ratings Ontero XR is available as a constant current or a DALI version. The 41W version is available either as a DALI version or with a potentiometer.

REFLECTOR	COL	927	830	835	840	PEARLWHITE	BECOLOR	BECOOL
<b>15W</b>								
NarrowSpot 10°	■	20760004	20760001	20760002	20760003	20760019	20760005	20760006
	■	20760010	20760007	20760008	20760009	20760020	20760011	20760012
	□	20760016	20760013	20760014	20760015	20760021	20760017	20760018
Spot 20°	■	20770004	20770001	20770002	20770003	20770010	20770005	20770006
	■	20770016	20770013	20770014	20770015	20770022	20770017	20770018
	□	20770028	20770025	20770026	20770027	20770034	20770029	20770030
Medium 25°	■	20780004	20780001	20780002	20780003	20780010	20780005	20780006
	■	20780016	20780013	20780014	20780015	20780022	20780017	20780018
	□	20780028	20780025	20780026	20780027	20780034	20780029	20780030
Flood 44°	■	20790004	20790001	20790002	20790003	20790010	20790005	20790006
	■	20790016	20790013	20790014	20790015	20790022	20790017	20790018
	□	20790028	20790025	20790026	20790027	20790034	20790029	20790030
OvalBasic 60°x40°	■	20800004	20800001	20800002	20800003	20800010	20800005	20800006
	■	20800016	20800013	20800014	20800015	20800022	20800017	20800018
	□	20800028	20800025	20800026	20800027	20800034	20800029	20800030
<b>15W DALI</b>								
NarrowSpot 10°	■	20820004	20820001	20820002	20820003	20820019	20820005	20820006
	■	20820010	20820007	20820008	20820009	20820020	20820011	20820012
	□	20820016	20820013	20820014	20820015	20820021	20820017	20820018
Spot 20°	■	20830004	20830001	20830002	20830003	20830010	20830005	20830006
	■	20830016	20830013	20830014	20830015	20830022	20830017	20830018
	□	20830028	20830025	20830026	20830027	20830034	20830029	20830030
Medium 25°	■	20840004	20840001	20840002	20840003	20840010	20840005	20840006
	■	20840016	20840013	20840014	20840015	20840022	20840017	20840018
	□	20840028	20840025	20840026	20840027	20840034	20840029	20840030
Flood 44°	■	20850004	20850001	20850002	20850003	20850010	20850005	20850006
	■	20850016	20850013	20850014	20850015	20850022	20850017	20850018
	□	20850028	20850025	20850026	20850027	20850034	20850029	20850030
OvalBasic 60°x40°	■	20860004	20860001	20860002	20860003	20860010	20860005	20860006
	■	20860016	20860013	20860014	20860015	20860022	20860017	20860018
	□	20860028	20860025	20860026	20860027	20860034	20860029	20860030
<b>23W</b>								
Spot 20°	■	20770040	20770037	20770038	20770039	20770046	20770041	20770042
	■	20770052	20770049	20770050	20770051	20770058	20770053	20770054
	□	20770064	20770061	20770062	20770063	20770070	20770065	20770066
Medium 25°	■	20780040	20780037	20780038	20780039	20780046	20780041	20780042
	■	20780052	20780049	20780050	20780051	20780058	20780053	20780054
	□	20780064	20780061	20780062	20780063	20780070	20780065	20780066
Flood 44°	■	20790040	20790037	20790038	20790039	20790046	20790041	20790042
	■	20790052	20790049	20790050	20790051	20790058	20790053	20790054
	□	20790064	20790061	20790062	20790063	20790070	20790065	20790066
OvalBasic 60°x40°	■	20800040	20800037	20800038	20800039	20800046	20800041	20800042
	■	20800052	20800049	20800050	20800051	20800058	20800053	20800054
	□	20800064	20800061	20800062	20800063	20800070	20800065	20800066

Contact [service@baero.com](mailto:service@baero.com) for individual price information. Please refer to our data sheets at [www.baero.com](http://www.baero.com) for further technical details on the individual products. The luminaire luminous flux figures vary in a tolerance range of ± 10%. All data are typical values. System features may change with product improvements due to technical advances. Errors excepted.

## XR PRODUCT NUMBERS

REFLECTOR	COL	927	830	835	840	PEARLWHITE	BECOLOR	BECOOOL
<b>23W DALI</b>								
Spot 20°	■	20830040	20830037	20830038	20830039	20830046	20830041	20830042
	■	20830052	20830049	20830050	20830051	20830058	20830053	20830054
	□	20830064	20830061	20830062	20830063	20830070	20830065	20830066
Medium 25°	■	20840040	20840037	20840038	20840039	20840046	20840041	20840042
	■	20840052	20840049	20840050	20840051	20840058	20840053	20840054
	□	20840064	20840061	20840062	20840063	20840070	20840065	20840066
Flood 44°	■	20850040	20850037	20850038	20850039	20850046	20850041	20850042
	■	20850052	20850049	20850050	20850051	20850058	20850053	20850054
	□	20850064	20850061	20850062	20850063	20850070	20850065	20850066
OvalBasic 60°x40°	■	20860040	20860037	20860038	20860039	20860046	20860041	20860042
	■	20860052	20860049	20860050	20860051	20860058	20860053	20860054
	□	20860064	20860061	20860062	20860063	20860070	20860065	20860066
<b>34W</b>								
Spot 20°	■	20770090	20770087	20770088	20770089	20770093	20770091	20770092
	■	20770097	20770094	20770095	20770096	20770100	20770098	20770099
	□	20770104	20770101	20770102	20770103	20770107	20770105	20770106
Medium 25°	■	20780090	20780087	20780088	20780089	20780093	20780091	20780092
	■	20780097	20780094	20780095	20780096	20780100	20780098	20780099
	□	20780104	20780101	20780102	20780103	20780107	20780105	20780106
Flood 44°	■	20790090	20790087	20790088	20790089	20790093	20790091	20790092
	■	20790097	20790094	20790095	20790096	20790100	20790098	20790099
	□	20790104	20790101	20790102	20790103	20790107	20790105	20790106
OvalBasic 60°x40°	■	20800090	20800087	20800088	20800089	20800093	20800091	20800092
	■	20800097	20800094	20800095	20800096	20800100	20800098	20800099
	□	20800104	20800101	20800102	20800103	20800107	20800105	20800106
<b>34W DALI</b>								
Spot 20°	■	20830090	20830087	20830088	20830089	20830093	20830091	20830092
	■	20830097	20830094	20830095	20830096	20830100	20830098	20830099
	□	20830104	20830101	20830102	20830103	20830107	20830105	20830106
Medium 25°	■	20840090	20840087	20840088	20840089	20840093	20840091	20840092
	■	20840097	20840094	20840095	20840096	20840100	20840098	20840099
	□	20840104	20840101	20840102	20840103	20840107	20840105	20840106
Flood 44°	■	20850090	20850087	20850088	20850089	20850093	20850091	20850092
	■	20850097	20850094	20850095	20850096	20850100	20850098	20850099
	□	20850104	20850101	20850102	20850103	20850107	20850105	20850106
OvalBasic 60°x40°	■	20860090	20860087	20860088	20860089	20860093	20860091	20860092
	■	20860097	20860094	20860095	20860096	20860100	20860098	20860099
	□	20860104	20860101	20860102	20860103	20860107	20860105	20860106

Contact [service@baero.com](mailto:service@baero.com) for individual price information. Please refer to our data sheets at [www.baero.com](http://www.baero.com) for further technical details on the individual products. The luminaire luminous flux figures vary in a tolerance range of  $\pm 10\%$ . All data are typical values. System features may change with product improvements due to technical advances. Errors excepted.

# Ontero XR

Surface-mounted luminaire with power adapter

In the 15W, 23W and 34W power ratings Ontero XR is available as a constant current or a DALI version. The 41W version is available either as a DALI version or with a potentiometer.

REFLECTOR	COL	927	830	835	840	PEARLWHITE	BECOLOR	BECOOL
<b>41 W POTI</b>								
Spot 20°	■	20890040	20890037	20890038	20890039	20890043	20890041	20890042
	■	20890047	20890044	20890045	20890046	20890050	20890048	20890049
	□	20890054	20890051	20890052	20890053	20890057	20890055	20890056
Medium 25°	■	20900040	20900037	20900038	20900039	20900043	20900041	20900042
	■	20900047	20900044	20900045	20900046	20900050	20900048	20900049
	□	20900054	20900051	20900052	20900053	20900057	20900055	20900056
Flood 44°	■	20910040	20910037	20910038	20910039	20910043	20910041	20910042
	■	20910047	20910044	20910045	20910046	20910050	20910048	20910049
	□	20910054	20910051	20910052	20910053	20910057	20910055	20910056
OvalBasic 60°x40°	■	20920040	20920037	20920038	20920039	20920043	20920041	20920042
	■	20920047	20920044	20920045	20920046	20920050	20920048	20920049
	□	20920054	20920051	20920052	20920053	20920057	20920055	20920056
<b>41 W DALI</b>								
Spot 20°	■	20830111	20830108	20830109	20830110	20830114	20830112	20830113
	■	20830118	20830115	20830116	20830117	20830121	20830119	20830120
	□	20830125	20830122	20830123	20830124	20830128	20830126	20830127
Medium 25°	■	20840111	20840108	20840109	20840110	20840114	20840112	20840113
	■	20840118	20840115	20840116	20840117	20840121	20840119	20840120
	□	20840125	20840122	20840123	20840124	20840128	20840126	20840127
Flood 44°	■	20850111	20850108	20850109	20850110	20850114	20850112	20850113
	■	20850118	20850115	20850116	20850117	20850121	20850119	20850120
	□	20850125	20850122	20850123	20850124	20850128	20850126	20850127
OvalBasic 60°x40°	■	20860111	20860108	20860109	20860110	20860114	20860112	20860113
	■	20860118	20860115	20860116	20860117	20860121	20860119	20860120
	□	20860125	20860122	20860123	20860124	20860128	20860126	20860127

Contact [service@baero.com](mailto:service@baero.com) for individual price information. Please refer to our data sheets at [www.baero.com](http://www.baero.com) for further technical details on the individual products. The luminaire luminous flux figures vary in a tolerance range of ± 10%. All data are typical values. System features may change with product improvements due to technical advances. Errors excepted.

# Ontero XR

Surface-mounted luminaire with in-track adapter

The Ontero XR with in-track adapter is available in 15W and 34W versions.

REFLECTOR	COL	927	830	835	840	PEARLWHITE	BECOLOR	BECOO
<b>15W</b>								
Spot 20°	■	20530004	20530001	20530002	20530003	20530007	20530005	20530006
	■	20530011	20530008	20530009	20530010	20530014	20530012	20530013
	□	20530018	20530015	20530016	20530017	20530021	20530019	20530020
Medium 25°	■	20540004	20540001	20540002	20540003	20540007	20540005	20540006
	■	20540011	20540008	20540009	20540010	20540014	20540012	20540013
	□	20540018	20540015	20540016	20540017	20540021	20540019	20540020
Flood 44°	■	20550004	20550001	20550002	20550003	20550007	20550005	20550006
	■	20550011	20550008	20550009	20550010	20550014	20550012	20550013
	□	20550018	20550015	20550016	20550017	20550021	20550019	20550020
OvalBasic 60°x40°	■	20560004	20560001	20560002	20560003	20560007	20560005	20560006
	■	20560011	20560008	20560009	20560010	20560014	20560012	20560013
	□	20560018	20560015	20560016	20560017	20560021	20560019	20560020
<b>34W</b>								
Spot 20°	■	20530025	20530022	20530023	20530024	20530028	20530026	20530027
	■	20530032	20530029	20530030	20530031	20530035	20530033	20530034
	□	20530039	20530036	20530037	20530038	20530042	20530040	20530041
Medium 25°	■	20540025	20540022	20540023	20540024	20540028	20540026	20540027
	■	20540032	20540029	20540030	20540031	20540035	20540033	20540034
	□	20540039	20540036	20540037	20540038	20540042	20540040	20540041
Flood 44°	■	20550025	20550022	20550023	20550024	20550028	20550026	20550027
	■	20550032	20550029	20550030	20550031	20550035	20550033	20550034
	□	20550039	20550036	20550037	20550038	20550042	20550040	20550041
OvalBasic 60°x40°	■	20560025	20560022	20560023	20560024	20560028	20560026	20560027
	■	20560032	20560029	20560030	20560031	20560035	20560033	20560034
	□	20560039	20560036	20560037	20560038	20560042	20560040	20560041

# Intara XR

## Semi-recessed luminaire

The separate driver unit is supplied with a feed-through wiring set. The luminaire is also available as a DALI version for integration in a light control system. In the 41 W version the brightness can be adjusted manually with a potentiometer.

REFLECTOR	COL	927	830	835	840	PEARLWHITE	BECOLOR	BECOOL
<b>15 W</b>								
NarrowSpot 10°	■	50690004	50690001	50690002	50690003	50690019	50690005	50690006
	■	50690010	50690007	50690008	50690009	50690020	50690011	50690012
	□	50690016	50690013	50690014	50690015	50690021	50690017	50690018
<b>15 / 23 / 34 / 41 W CONSTANT CURRENT + DALI</b>								
Spot 20°	■	50700004	50700001	50700002	50700003	50700010	50700005	50700006
	■	50700016	50700013	50700014	50700015	50700022	50700017	50700018
	□	50700028	50700025	50700026	50700027	50700034	50700029	50700030
Medium 25°	■	50710004	50710001	50710002	50710003	50710010	50710005	50710006
	■	50710016	50710013	50710014	50710015	50710022	50710017	50710018
	□	50710028	50710025	50710026	50710027	50710034	50710029	50710030
Flood 44°	■	50720004	50720001	50720002	50720003	50720010	50720005	50720006
	■	50720016	50720013	50720014	50720015	50720022	50720017	50720018
	□	50720028	50720025	50720026	50720027	50720034	50720029	50720030
OvalBasic 60°x40°	■	50730004	50730001	50730002	50730003	50730010	50730005	50730006
	■	50730016	50730013	50730014	50730015	50730022	50730017	50730018
	□	50730028	50730025	50730026	50730027	50730034	50730029	50730030
<b>41 W POTENTIOMETER</b>								
Spot 20°	■	50750004	50750001	50750002	50750003	50750007	50750005	50750006
	■	50750011	50750008	50750009	50750010	50750014	50750012	50750013
	□	50750018	50750015	50750016	50750017	50750021	50750019	50750020
Medium 25°	■	50760004	50760001	50760002	50760003	50760007	50760005	50760006
	■	50760011	50760008	50760009	50760010	50760014	50760012	50760013
	□	50760018	50760015	50760016	50760017	50760021	50760019	50760020
Flood 44°	■	50770004	50770001	50770002	50770003	50770007	50770005	50770006
	■	50770011	50770008	50770009	50770010	50770014	50770012	50770013
	□	50770018	50770015	50770016	50770017	50770021	50770019	50770020
OvalBasic 60°x40°	■	50780004	50780001	50780002	50780003	50780007	50780005	50780006
	■	50780011	50780008	50780009	50780010	50780014	50780012	50780013
	□	50780018	50780015	50780016	50780017	50780021	50780019	50780020
<b>DRIVER UNIT</b>								
Constant Current		76500050	[400 mA/15 Watt]					
		76500034	[600 mA/23 Watt]					
		76500076	[850 mA/34 Watt]					
		76500037	[1,050 mA/41 Watt]					
DALI		76500051	[400 mA/15 Watt]					
		76500039	[600 mA/23 Watt]					
		76500077	[850 mA/34 Watt]					
		76500042	[1,050 mA/41 Watt]					
Potentiometer		76500109	[1,050 mA/41 Watt]					

**NB:** The driver units must be ordered separately.



# Intara XR

## Recessed luminaire

The recessed luminaire is supplied with a secondary fixed driver incl. primary side feed cable with GST 18/3 plug.

REFLECTOR	COL	927	830	835	840	PEARLWHITE	BECOLOR	BECOOL
<b>15W</b>								
NarrowSpot 10°	■	50860001	50860002	50860003	50860004	50860005	50860006	50860007
	■	50860008	50860009	50860010	50860011	50860012	50860013	50860014
	□	50860015	50860016	50860017	50860018	50860019	50860020	50860021
Spot 20°	■	50870001	50870002	50870003	50870004	50870005	50870006	50870007
	■	50870008	50870009	50870010	50870011	50870012	50870013	50870014
	□	50870015	50870016	50870017	50870018	50870019	50870020	50870021
Medium 25°	■	50880001	50880002	50880003	50880004	50880005	50880006	50880007
	■	50880008	50880009	50880010	50880011	50880012	50880013	50880014
	□	50880015	50880016	50880017	50880018	50880019	50880020	50880021
Flood 44°	■	50890001	50890002	50890003	50890004	50890005	50890006	50890007
	■	50890008	50890009	50890010	50890011	50890012	50890013	50890014
	□	50890015	50890016	50890017	50890018	50890019	50890020	50890021
OvalBasic 60°x40°	■	50900001	50900002	50900003	50900004	50900005	50900006	50900007
	■	50900008	50900009	50900010	50900011	50900012	50900013	50900014
	□	50900015	50900016	50900017	50900018	50900019	50900020	50900021
<b>23W</b>								
Spot 20°	■	50870022	50870023	50870024	50870025	50870026	50870027	50870028
	■	50870029	50870030	50870031	50870032	50870033	50870034	50870035
	□	50870036	50870037	50870038	50870039	50870040	50870041	50870042
Medium 25°	■	50880022	50880023	50880024	50880025	50880026	50880027	50880028
	■	50880029	50880030	50880031	50880032	50880033	50880034	50880035
	□	50880036	50880037	50880038	50880039	50880040	50880041	50880042
Flood 44°	■	50890022	50890023	50890024	50890025	50890026	50890027	50890028
	■	50890029	50890030	50890031	50890032	50890033	50890034	50890035
	□	50890036	50890037	50890038	50890039	50890040	50890041	50890042
OvalBasic 60°x40°	■	50900022	50900023	50900024	50900025	50900026	50900027	50900028
	■	50900029	50900030	50900031	50900032	50900033	50900034	50900035
	□	50900036	50900037	50900038	50900039	50900040	50900041	50900042
<b>34W</b>								
Spot 20°	■	50870043	50870044	50870045	50870046	50870047	50870048	50870049
	■	50870050	50870051	50870052	50870053	50870054	50870055	50870056
	□	50870057	50870058	50870059	50870060	50870061	50870062	50870063
Medium 25°	■	50880043	50880044	50880045	50880046	50880047	50880048	50880049
	■	50880050	50880051	50880052	50880053	50880054	50880055	50880056
	□	50880057	50880058	50880059	50880060	50880061	50880062	50880063
Flood 44°	■	50890043	50890044	50890045	50890046	50890047	50890048	50890049
	■	50890050	50890051	50890052	50890053	50890054	50890055	50890056
	□	50890057	50890058	50890059	50890060	50890061	50890062	50890063
OvalBasic 60°x40°	■	50900043	50900044	50900045	50900046	50900047	50900048	50900049
	■	50900050	50900051	50900052	50900053	50900054	50900055	50900056
	□	50900057	50900058	50900059	50900060	50900061	50900062	50900063

# Pendiro XR

## Suspended luminaire

The variants with track-mounted canopy or surface-mounted canopy are always supplied as a DALI version. The separate driver unit is included in the scope of supply of the variant with a recessed ceiling canopy. When placing your order please state the driver unit product number with the desired power output.

REFLECTOR	COL	927	830	835	840	PEARLWHITE	BECOLOR	BECOOL
<b>TRACK-MOUNTED CANOPY</b>								
<b>15W DALI</b>								
NarrowSpot 10°	■	80720004	80720001	80720002	80720003	80720019	80720005	80720006
	■	80720010	80720007	80720008	80720009	80720020	80720011	80720012
	□	80720016	80720013	80720014	80720015	80720021	80720017	80720018
Spot 20°	■	80730004	80730001	80730002	80730003	80730010	80730005	80730006
	■	80730016	80730013	80730014	80730015	80730022	80730017	80730018
	□	80730028	80730025	80730026	80730027	80730034	80730029	80730030
Medium 25°	■	80740004	80740001	80740002	80740003	80740010	80740005	80740006
	■	80740016	80740013	80740014	80740015	80740022	80740017	80740018
	□	80740028	80740025	80740026	80740027	80740034	80740029	80740030
Flood 44°	■	80750004	80750001	80750002	80750003	80750010	80750005	80750006
	■	80750016	80750013	80750014	80750015	80750022	80750017	80750018
	□	80750028	80750025	80750026	80750027	80750034	80750029	80750030
<b>23W DALI</b>								
Spot 20°	■	80730040	80730037	80730038	80730039	80730046	80730041	80730042
	■	80730052	80730049	80730050	80730051	80730058	80730053	80730054
	□	80730064	80730061	80730062	80730063	80730070	80730065	80730066
Medium 25°	■	80740040	80740037	80740038	80740039	80740046	80740041	80740042
	■	80740052	80740049	80740050	80740051	80740058	80740053	80740054
	□	80740064	80740061	80740062	80740063	80740070	80740065	80740066
Flood 44°	■	80750040	80750037	80750038	80750039	80750046	80750041	80750042
	■	80750052	80750049	80750050	80750051	80750058	80750053	80750054
	□	80750064	80750061	80750062	80750063	80750070	80750065	80750066
<b>SURFACE-MOUNTED CANOPY</b>								
<b>15W DALI</b>								
NarrowSpot 10°	■	80760004	80760001	80760002	80760003	80760019	80760005	80760006
	■	80760010	80760007	80760008	80760009	80760020	80760011	80760012
	□	80760016	80760013	80760014	80760015	80760021	80760017	80760018
Spot 20°	■	80770004	80770001	80770002	80770003	80770010	80770005	80770006
	■	80770016	80770013	80770014	80770015	80770022	80770017	80770018
	□	80770028	80770025	80770026	80770027	80770034	80770029	80770030
Medium 25°	■	80780004	80780001	80780002	80780003	80780010	80780005	80780006
	■	80780016	80780013	80780014	80780015	80780022	80780017	80780018
	□	80780028	80780025	80780026	80780027	80780034	80780029	80780030
Flood 44°	■	80790004	80790001	80790002	80790003	80790010	80790005	80790006
	■	80790016	80790013	80790014	80790015	80790022	80790017	80790018
	□	80790028	80790025	80790026	80790027	80790034	80790029	80790030
<b>23W DALI</b>								
Spot 20°	■	80770040	80770037	80770038	80770039	80770046	80770041	80770042
	■	80770052	80770049	80770050	80770051	80770058	80770053	80770054
	□	80770064	80770061	80770062	80770063	80770070	80770065	80770066
Medium 25°	■	80780040	80780037	80780038	80780039	80780046	80780041	80780042
	■	80780052	80780049	80780050	80780051	80780058	80780053	80780054
	□	80780064	80780061	80780062	80780063	80780070	80780065	80780066
Flood 44°	■	80790040	80790037	80790038	80790039	80790046	80790041	80790042
	■	80790052	80790049	80790050	80790051	80790058	80790053	80790054
	□	80790064	80790061	80790062	80790063	80790070	80790065	80790066

Contact [service@baero.com](mailto:service@baero.com) for individual price information. Please refer to our data sheets at [www.baero.com](http://www.baero.com) for further technical details on the individual products. The luminaire luminous flux figures vary in a tolerance range of  $\pm 10\%$ . All data are typical values. System features may change with product improvements due to technical advances. Errors excepted.

REFLECTOR	COL	927	830	835	840	PEARLWHITE	BECOLOR	BECOO
<b>RECESSED CANOPY</b>								
<b>15W</b>								
NarrowSpot 10°	■	80800004	80800001	80800002	80800003	80800019	80800005	80800006
	■	80800010	80800007	80800008	80800009	80800020	80800011	80800012
	□	80800016	80800013	80800014	80800015	80800021	80800017	80800018
<b>15 / 23 W</b>								
Spot 20°	■	80810004	80810001	80810002	80810003	80810010	80810005	80810006
	■	80810016	80810013	80810014	80810015	80810022	80810017	80810018
	□	80810028	80810025	80810026	80810027	80810034	80810029	80810030
Medium 25°	■	80820004	80820001	80820002	80820003	80820010	80820005	80820006
	■	80820016	80820013	80820014	80820015	80820022	80820017	80820018
	□	80820028	80820025	80820026	80820027	80820034	80820029	80820030
Flood 44°	■	80830004	80830001	80830002	80830003	80830010	80830005	80830006
	■	80830016	80830013	80830014	80830015	80830022	80830017	80830018
	□	80830028	80830025	80830026	80830027	80830034	80830029	80830030

**DRIVER UNIT FOR CEILING INSTALLATION**

Constant Current	76500050	[400mA/15 Watt]
	76500034	[600mA/23 Watt]
DALI	76500051	[400mA/15 Watt]
	76500039	[600mA/23 Watt]

**NB:** The driver units must be ordered separately.

# Accessories

for Ontero, Intara and Pendiro XR

HONEYCOMB LOUVER	40020001
ANTI-GLARE FLAPS	40020011



# BÄRO – Your lighting partner. Right from the start.

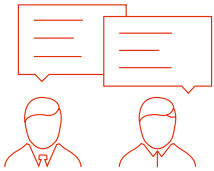

## > ADVICE Discover the potential.

A fundamental aspect of our advice is to convey to all those involved in the project the huge potential and the many nuanced possibilities of expression offered by the medium light today thanks to LED technology. Talk to our lighting consultants and find out about the impact that BÄRO products can have in your store – not just in view of effectiveness and efficiency, but also and especially in terms of the emotionality of light.



## > PLANNING Light that suits you.

Light can be designed in many different qualities and dimensions. Sophisticated light planning not only supports the dramaturgy of the shopping experience; it also allows the lighting to be perfectly tailored to the different visual tasks and product groups. We are committed to finding a customised, expressive light balance for every concept – through the interplay of light distribution and light channelling, light intensities and light colours.

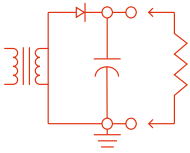

## > INSTALLATION On site together.

Careful and professional installation is just as important as effective and creative lighting planning. BÄRO supports you in the installation and alignment of luminaires on site – so that your customised lighting concept rapidly takes shape and unforeseen issues are quickly resolved. In this way you can be sure that the lighting is perfectly focused on the room and the products.

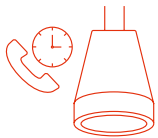

## > SUPPORT Long-term cooperation.

Our products boast long-lasting quality and functionality. Nonetheless, our service does not end when your lighting system is put into operation. BÄRO is available to answer your questions and provide services even after completion of the project.



## > LEASING Efficient lighting. Financed effectively.

Customised financing for a customised lighting concept. Whether you are a retailer or a retail brand, we will be pleased to advise you on a leasing concept that suits your specific needs. Together we will draw up a contract that caters to your wishes and the needs of your company. Contact us. We're pleased to assist you.

## > CONTACT

Tel.: +49 800 799 1000/e-mail: [service@baero.com](mailto:service@baero.com)

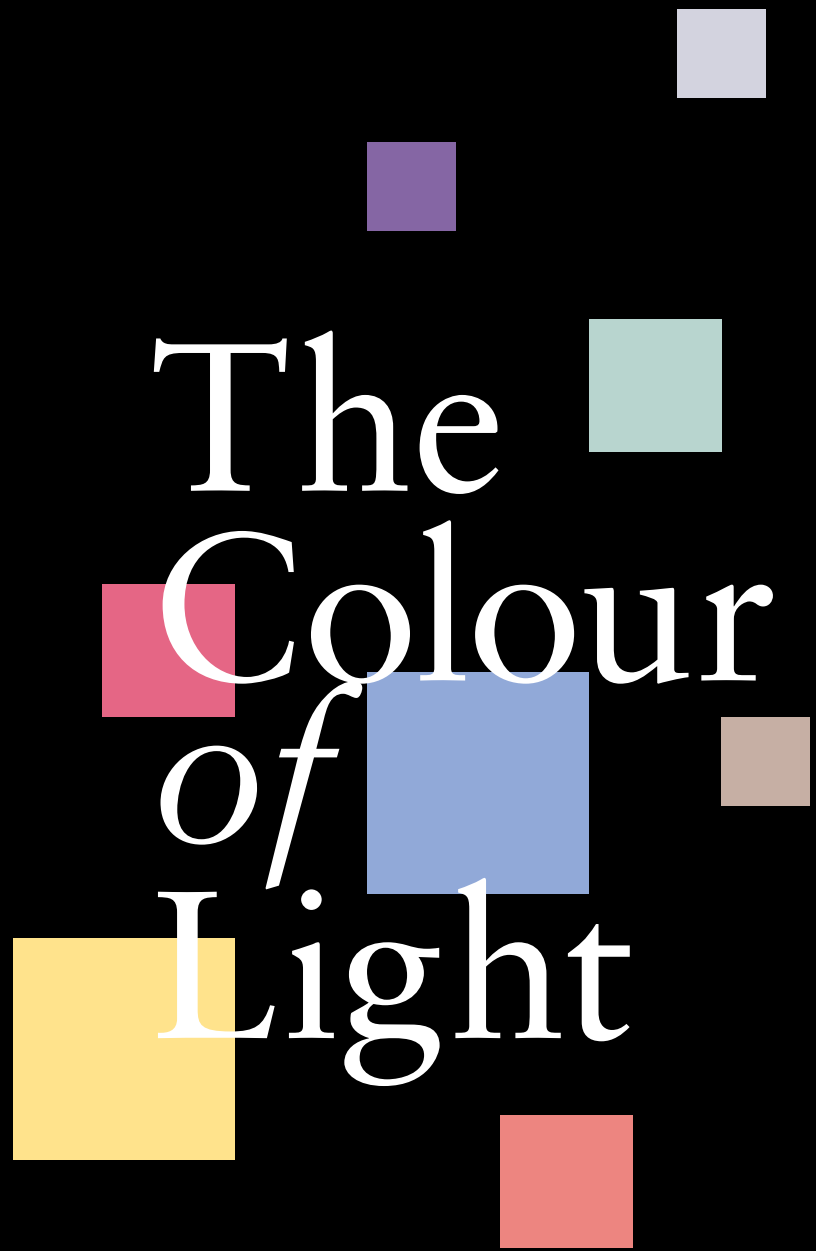

# The Colour *of* Light

BÄRO GmbH & Co. KG  
Wolfstall 54-56  
42799 Leichlingen

T +49 2174 799 0  
F +49 2174 799 799  
[www.baero.com](http://www.baero.com)